

Monolithic Power Systems(MPWR)

기본 개요

주가(달러, 6/6)	497.41
시가총액(십억달러)	23.59
52주 최고가(달러)	553.64
52주 최저가(달러)	301.69
평균 거래량(백만주)	0.59

Price Chart

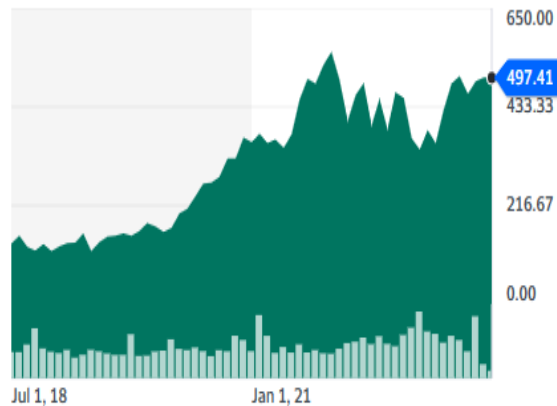

주가 수익률

	1개월	6개월	12개월
절대주가(%)	18.1	28.9	8.9
상대주가(%p)	11.2	10.6	0.5

투자 포인트

- **DC/DC 전력 반도체 글로벌 선두 기업.** 엔비디아의 H100 제품의 단독 서플라이어 글로벌 점유율 10% 중반 추정. 전체 매출 내 DC/DC 반도체 비중 95%로 pure play
- **전방 기술 트렌드 변화는 DC/DC 반도체 수요의 구조적 성장으로 이어져.** AI, 클라우드, 전기차 산업 성장으로 전력 관리/효율화 니즈 급상승 → DC/DC 컨버터 기술적 중요성 및 수요 레벨업
- **전통 IT사업 영역도 바닥 찍고 반등 전망.** 컨슈머, 스토리지 등 IT산업 하반기 점진적 회복 가능성 높아. AI, 전기차 모멘텀 이외 업황 반등 수혜도 기대

	FY19	FY20	FY21	FY22	FY23F	FY24F
매출액(백만달러)	628	844	1,208	1,794	1,844	2,146
매출총이익(백만달러)	349	469	689	1,053	1,050	1,237
매출총이익률(%)	55.6	55.6	57.1	58.7	57.0	57.6
영업이익(백만달러)	185	250	391	681	613	745
영업이익률(%)	29.5	29.6	32.4	38.0	33.3	34.7
순이익(백만달러)	178	237	357	600	586	694
순이익률(%)	28.3	28.0	29.5	33.4	31.8	32.3
EBITDA(백만달러)	200	269	420	718	672	831
EBITDA margin(%)	31.9	31.9	34.8	40.0	36.4	38.7
ROE(%)	15.7	18.9	21.9	30.1	31.6	28.5
배당수익률(%)	0.84	0.52	0.47	0.81	0.81	0.85
PER(배)	73.5	104.0	97.6	39.1	41.4	35.8
PSR(배)	13.0	20.0	19.6	9.5	12.7	10.9
EV/EBITDA(배)	61.0	85.0	53.7	31.4	33.5	27.1

(주: 12월말 회계연도 / 출처: 톰슨로이터)

Monolithic Power Systems(MPWR)

주식 시장 요약 > 모노리식 파워시스템

496.37 USD

+362.11 (269.71%) ↑ 지난 5년

6월 8일 오후 12:55 GMT-4 • 면책조항

1일 | 5일 | 1개월 | 6개월 | 연중 | 1년 | 5년 | 최대



Monolithic Power Systems(MPWR)

Monolithic Power Systems의 포지셔닝: AI와 전기차 산업 성장의 수혜 집중

	핵심 항목	주요 내용
전방산업 (성장배경)	IT업황 바텀 아웃 가능성	<ul style="list-style-type: none"> 23년 2분기를 기점으로 IT업황 반등 → 주요 제품 수요 회복
	AI, 전기차 등 성장산업 노출도 높아	<ul style="list-style-type: none"> 데이터센터향 서버향 DC-DC반도체 수요 구조적 성장 특히, AI서버 등 고사양 영역에서 높은 경쟁력 전기차, 인포테인먼트향 제품 수요도 구조적 성장
경쟁력 (경쟁환경)	높은 점유율 (퓨어 플레이)	<ul style="list-style-type: none"> 글로벌 점유율 10% 중후반 추정 AI 구현 가능 영역대 제품(A100, H100)에 있어 독점적 지위
	콘텐츠 growth 지속	<ul style="list-style-type: none"> 서버, 자동차 등 대당 탑재량 구조적으로 상승
추가 모멘텀	업황 턴어라운드 & AI모멘텀	<ul style="list-style-type: none"> 전방 재고조정 하반기 마무리 전망. 저점 지나고 있어 업황은 바닥권. AI 등 성장산업향 수요 서프라이즈 전망
	밸류에이션	<ul style="list-style-type: none"> 12MF EPS 기준 PER 32배 밸류에이션 re-rating 전망

Monolithic Power Systems(MPWR)

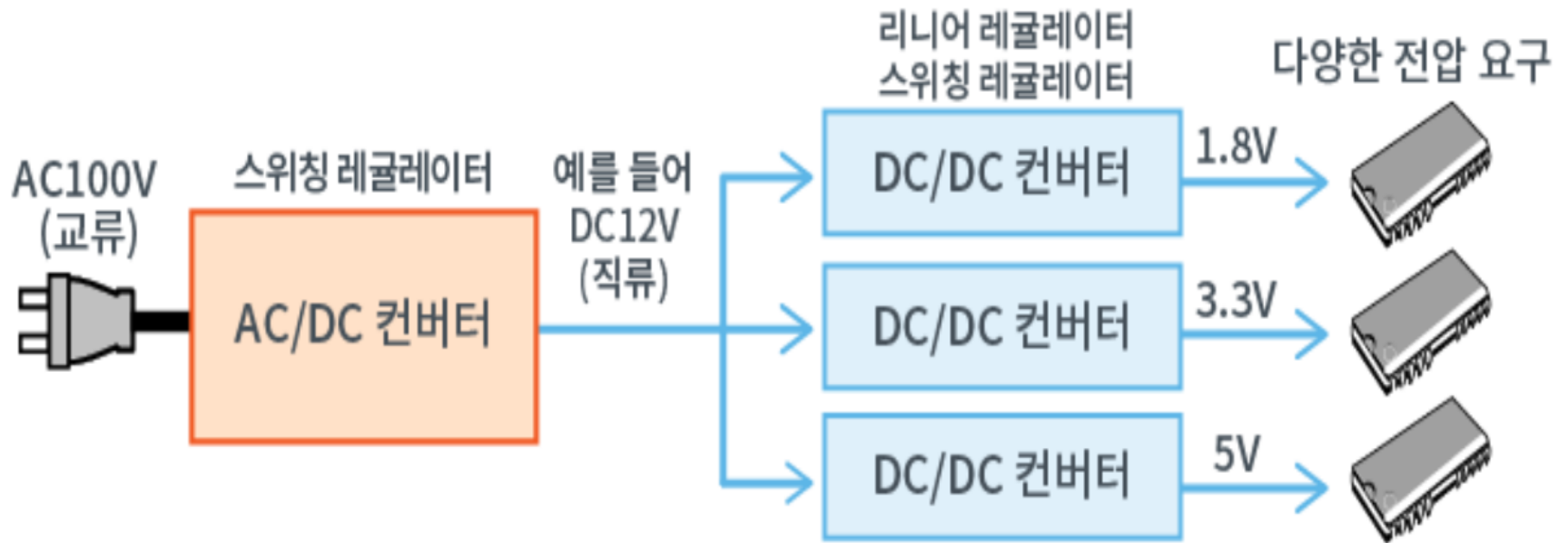

DC/DC 컨버터의 역할

Monolithic Power Systems(MPWR)



Monolithic Power Systems (Mps)
EVQ4480-V-00A Eval Board,
Synchronous Buck Converter

₩33,449
element14
배송비 ₩20,000



Monolithic Power Systems (Mps)
EV2182-TL-00A Eval Board,
Synchronous Buck Converter

₩33,719
element14
배송비 ₩20,000



Monolithic Power Systems (MPS)
MP6651GD-0000-P 모터 / 모션 /
정확 컨트롤러 및 드라이버

₩4,767
Mouser Korea
배송비 ₩20,000



Monolithic Power Systems (Mps)
MP9488GS-P Dc/dc Conv, Buck,
125Deg C

₩3,878
element14
배송비 ₩20,000



Monolithic Power Systems (MPS)
mEZD71202A-G 비절연형 DC/DC
컨버터

₩7,636
Mouser Korea
배송비 ₩20,000



Monolithic Power Systems (Mps)
EV9989-S-00A Eval Board,
Rectifier, Flyback Converter

₩35,463
element14
배송비 ₩20,000



Monolithic Power Systems (Mps)
MP1470GJ-P Dc/dc Conv, Sync
Buck, 490Khz, 125Deg C

₩2,621
element14
배송비 ₩20,000



[MPD] AC-DC 컨버터 모듈 (MPS-
03S)

₩29,689
나비엠알오
배송비 ₩3,000

Monolithic Power Systems(MPWR)

The screenshot displays the MPS website's navigation and product categories. The top navigation bar includes the MPS logo, a menu with 'Products', 'Applications', 'Design', 'Support', 'EMC Lab', 'About MPS', and 'Contact', a shopping cart icon with '0' items, and a language selector 'EN'. Below the navigation bar, the main content area is organized into four columns of product categories. The first column lists 'Power Management' products such as switching converters, multi-phase controllers, PMICs, and power protection. The second column lists 'Power Modules' including integrated inductors, DC/DC converters, and 48V modules. The third column lists 'Automotive (AECQ Grade)' products like switching converters, load switches, motor drivers, and USB charging ports. The fourth column lists 'Class-D Audio' products like analog input and PWM drivers. A 'Data Converters' category is highlighted with a 'NEW' badge, listing Delta-Sigma and SAR ADCs. Other categories include 'Isolation', 'Battery Management', 'Motor Drivers & Motor Controllers', and 'Inductors'. A 'Sensors' category is also visible. At the bottom, a 'New Products' banner is partially visible.

mPS Products Applications Design Support EMC Lab About MPS Contact CART 0 **EN**

Power Management

- Switching Converters & Controllers
- Multi Phase Controllers & Intelli-Phase
- Power Management IC (PMIC)
- Data Center **NEW**
- Power Protection
- Power Over Ethernet (PoE)
- Display Power and Control
- USB, Load & Analog Switches
- LDO & Voltage Supervisory
- MOSFET Drivers

Isolation

- Isolated Gate Drivers
- Digital Isolators
- Digital Isolators with Integrated Power
- Isolated DC/DC Converters & Modules
- Controllers

Power Modules

- Power Modules (Integrated Inductor)
- Isolated DC/DC Converters & Modules
- 48V Modules
- Intelli-Module

Battery Management

- Chargers
- Battery Monitors & Protectors
- Fuel Gauges
- Input Protection
- CC & CV Controllers

Motor Drivers & Motor Controllers

- Stepper Motor Drivers
- BLDC Pre Drivers and Integrated Solutions
- Brushed DC / Solenoid Drivers
- Fan Drivers
- Servo, BLDC Motor Controllers

Automotive (AECQ Grade)

- Switching Converters and Controllers AECQ Grade
- Load Switches and Supervisors
- Motor Drivers
- Power Modules
- USB Charging Port
- LED Driver
- LDO
- Half-Bridge
- Backlight Drivers (WLED)

Inductors

- Shielded Optimized for MPS DC DC
- Molded Optimized for MPS DC DC

Class-D Audio

- Analog Input
- PWM Input Power Drivers

Analog

- Ultrasound Multiplexers
- Precision Analog

Data Converters **NEW**

- Delta-Sigma ADCs
- SAR ADCs

Sensors

- Angular Position Sensors
- Current Sensors

New Products **NEW**

Power Modules | Magnetic | Monolithic ICs | AC DI

Monolithic Power Systems(MPWR)

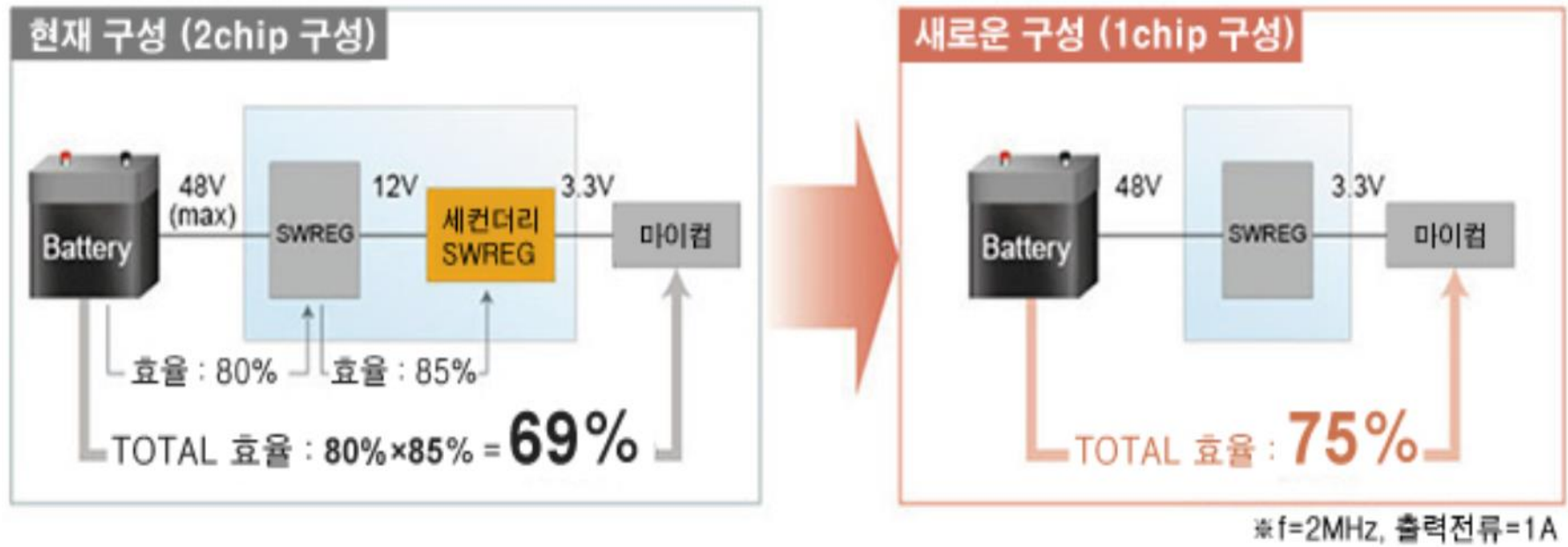

DC/DC전력전환을 일원화(일본 전력반도체 기업 ROHM의 자료)

Monolithic Power Systems(MPWR)

Great Revenue Diversification by GEO & End Customer

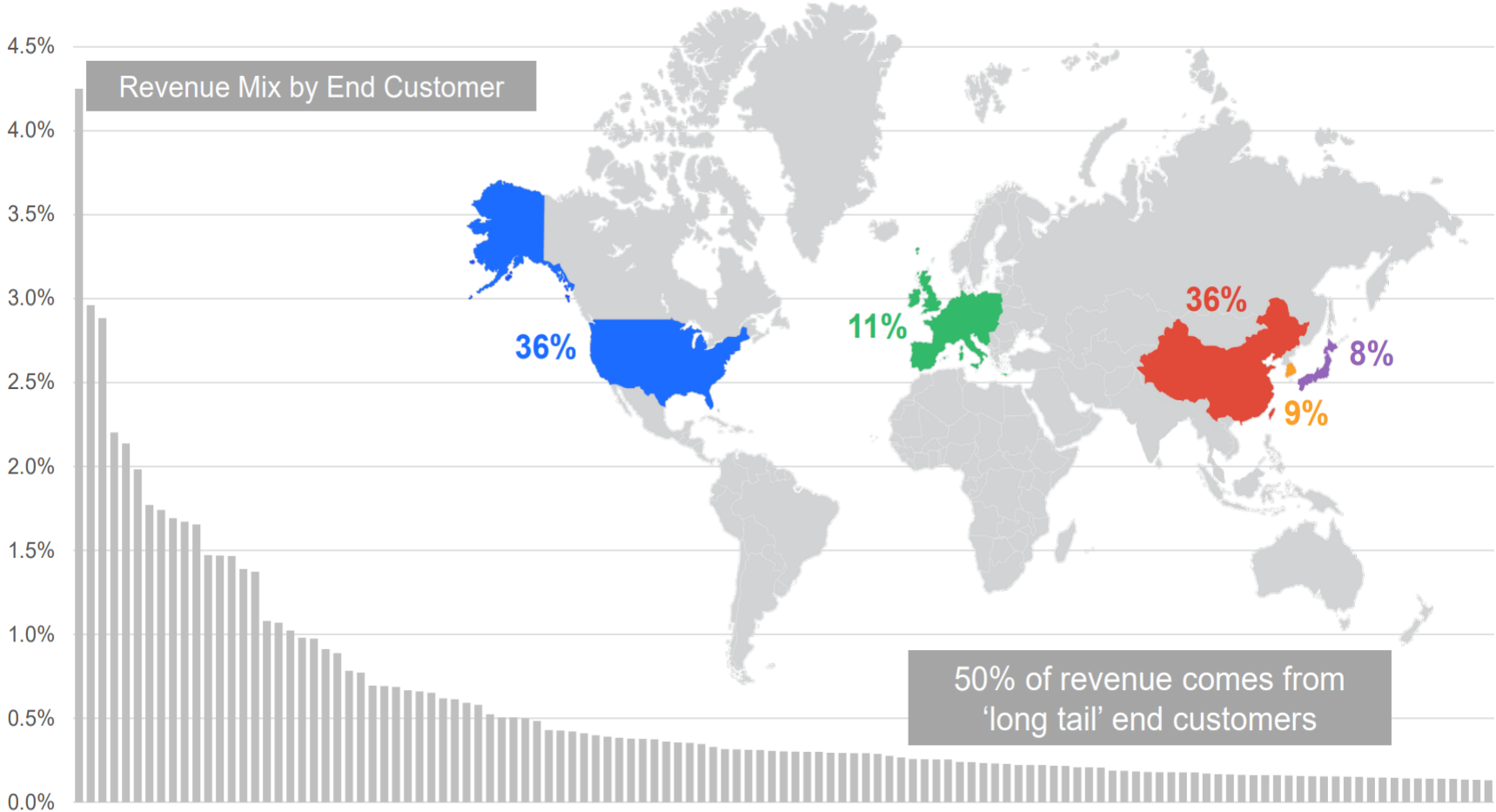

Monolithic Power Systems(MPWR)

SAM Expansion

Market	2015 SAM	2018 SAM	2021 SAM
Automotive	\$4B	\$6B	\$7B
Motion Control	\$2B	\$3B	\$4B
ACDC	\$1B	\$2B	\$2B
Modules	\$1B	\$2B	\$2B
Cloud Computing (Server / Storage)	\$800M	\$1B	\$4B
Networking / Telecom	\$600M	\$1B	\$1B
Battery Management	\$600M	\$1B	\$1B
Total Market SAM	\$10B	\$16B	\$21B

Monolithic Power Systems(MPWR)

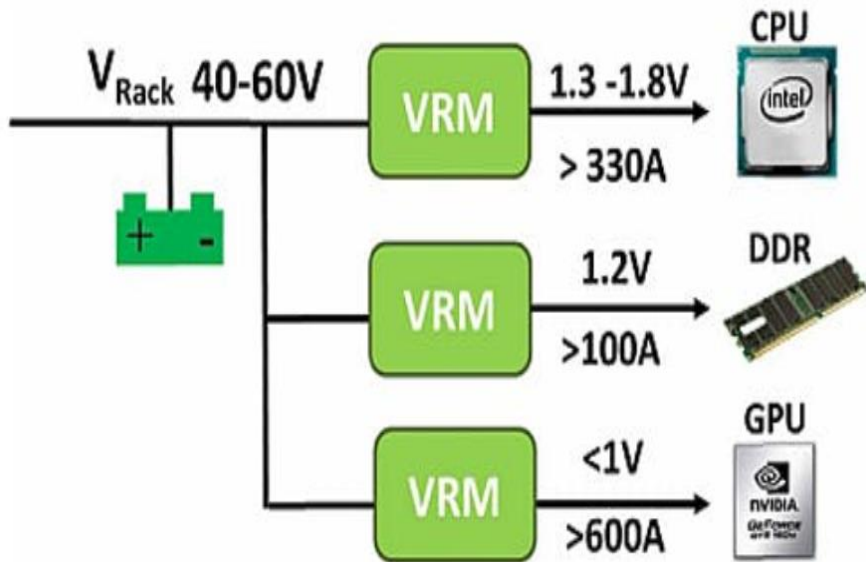

데이터센터 내 반도체 요구 전압 차이의 예

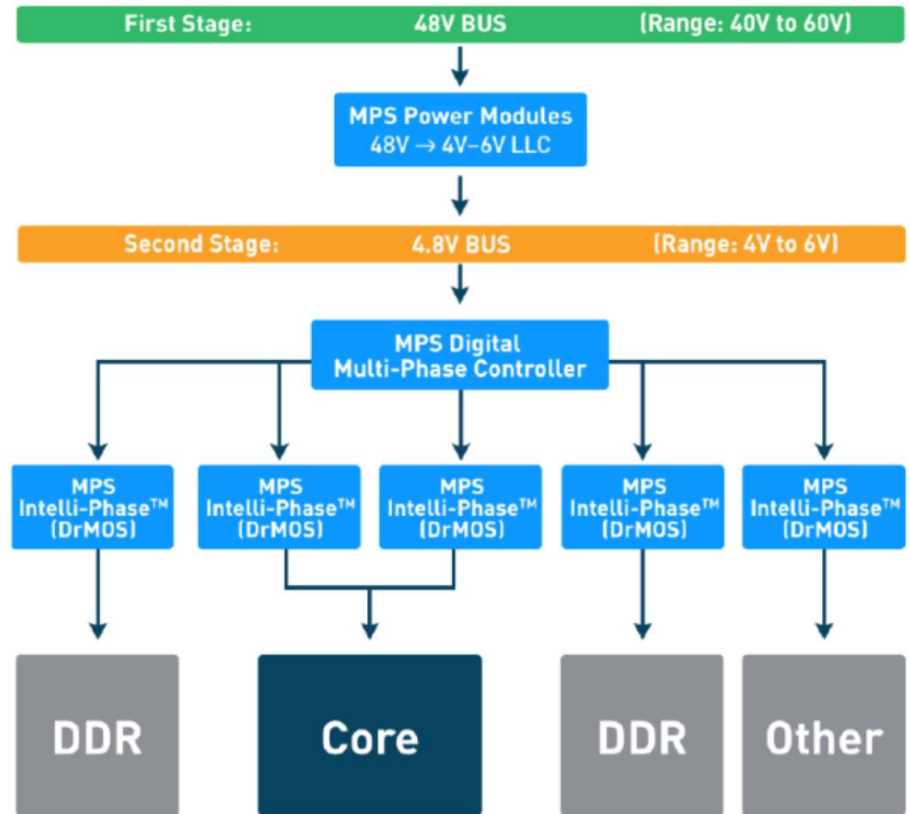
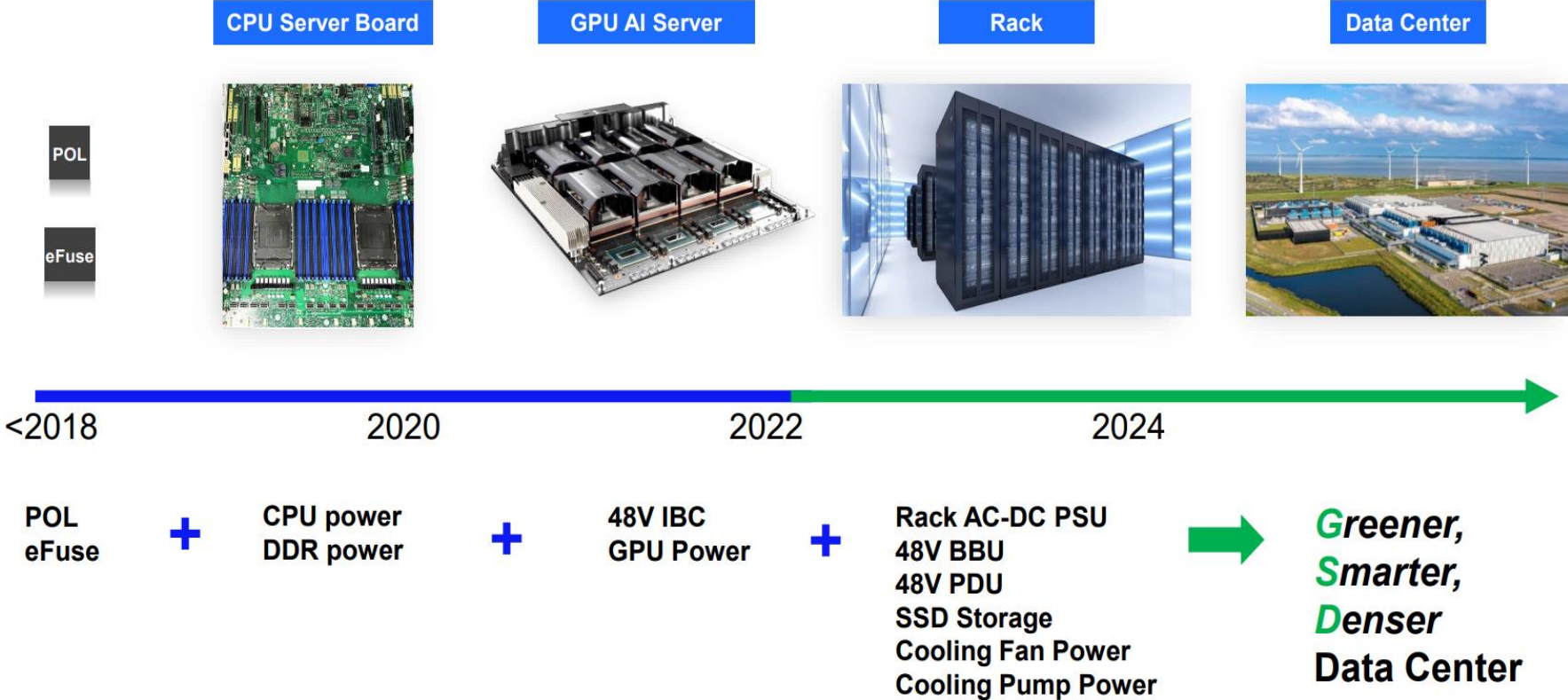

Figure 2: 48V Power Structure – MPS 4V to 6V System

48V 직류를 4~6V 직류로 한번에 낮추는 Monolithic Power Systems의 솔루션

Monolithic Power Systems(MPWR)

>\$4B SAM and Rapidly Growing



Monolithic Power Systems(MPWR)

Server Board Level Power Solutions

CPU Server: \$1B SAM

\$80 MPS Content / Server

- CPU Power**
\$600M SAM
- DDR5 Memory Power**
\$280M SAM
- Point of Load**
\$60M SAM
- EFuse**
\$60M SAM

GPU Server: \$500M SAM

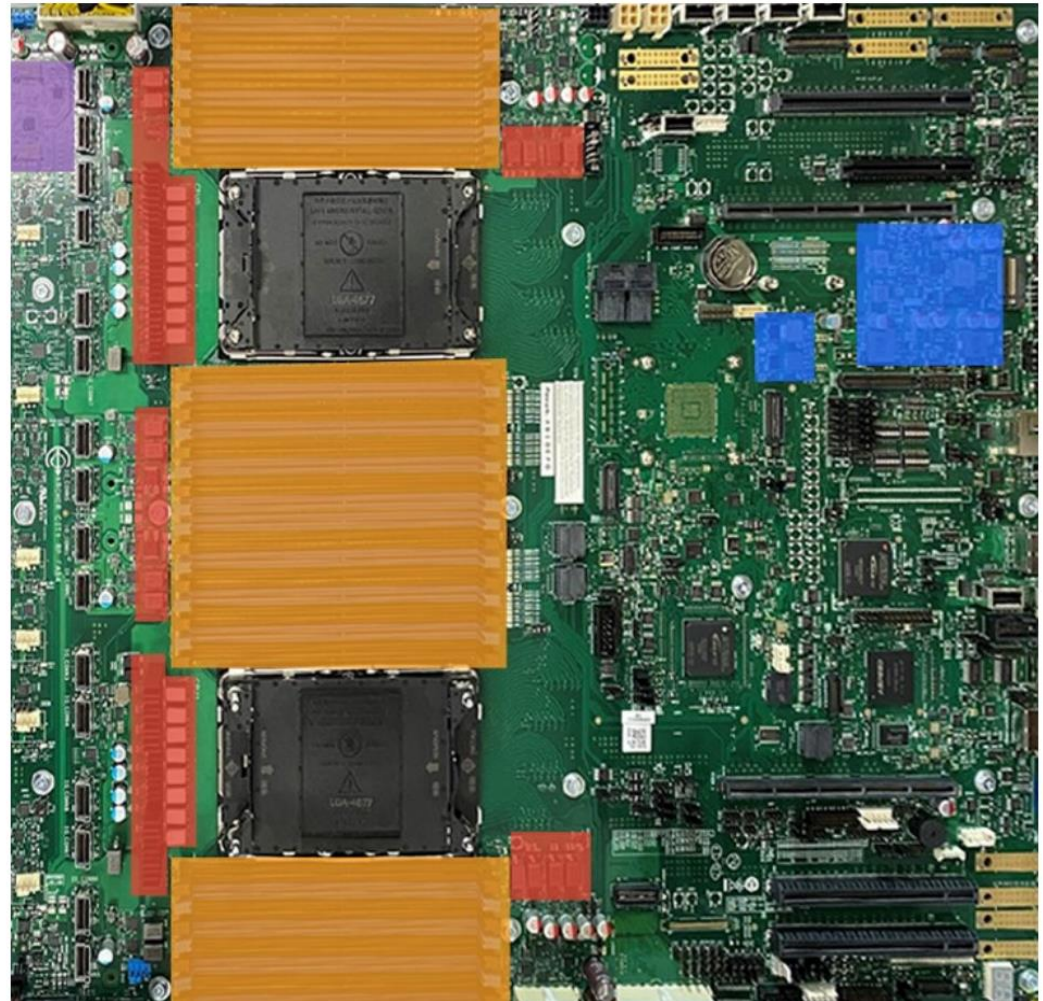

Monolithic Power Systems(MPWR)

Direct to Data Center Builders & Owners, Additional \$2B SAM

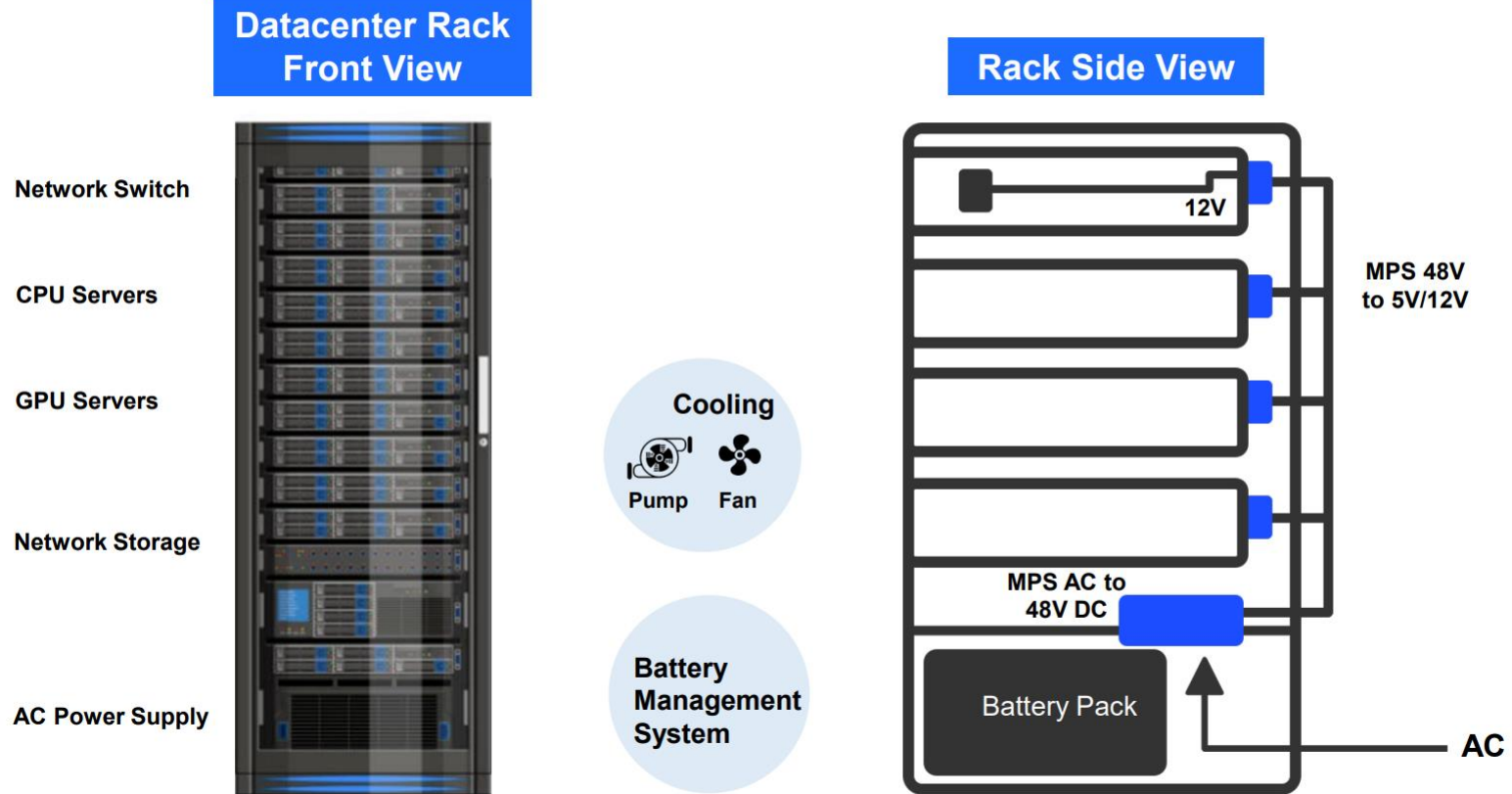

Monolithic Power Systems(MPWR)

Automotive Applications Covered

ADAS

- 360° Camera
- Front Camera
- Backup Camera
- Thermal Camera
- Driver Monitoring
- Cabin Sensing
- Sensor Fusion
- Radar
- LiDAR
- Ultrasonic
- A/V Computing

Digital Cockpit

- Infotainment
- E-Call
- Digital Mirror
- USB Charging
- Wireless Charging
- Telematics/V2X
- HUD
- Cluster
- Ambient Lighting

Body Control & Other

- Motor Modules
- Door Latch/Lock
- Keyless Entry
- Junction Box
- HVAC
- Gateway
- Liftgate
- Power Assisted Steering
- Suspension Sensor
- Wiper Motor
- Electronic Braking System
- Fluid Pumps
- Electronic Parking System
- Power Seat
- eShift

Electrification

- On-board Charger
- Traction Inverter
- On-board DC/DC
- 48V DC/DC
- Belt Start Generator
- DC Fast Charging Station
- Virtual Engine Noise

Lighting

- Daytime Running Lights
- Matrix Lights
- Fog Lights
- Headlamps
- Brake Lights/CHMSL
- Turn Indicator Lights

PRODUCT TYPES

- Buck, Buck-Boost & Boost Converters
- PMICs
- Linear Regulators
- Monitoring & Supervision
- Power Switches
- LED Lighting
- USB & Wireless Charging
- Motor Drivers
- Class-D Audio
- Position Sensors & Current Sensors
- Isolation Solutions
- GaN Driver
- MPSafe™

Monolithic Power Systems(MPWR)

Relentless Expansion of Product Categories

New Portfolio Launches

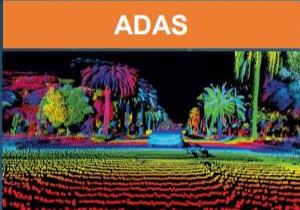
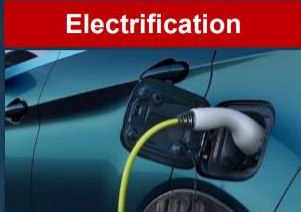

Monolithic Power Systems(MPWR)

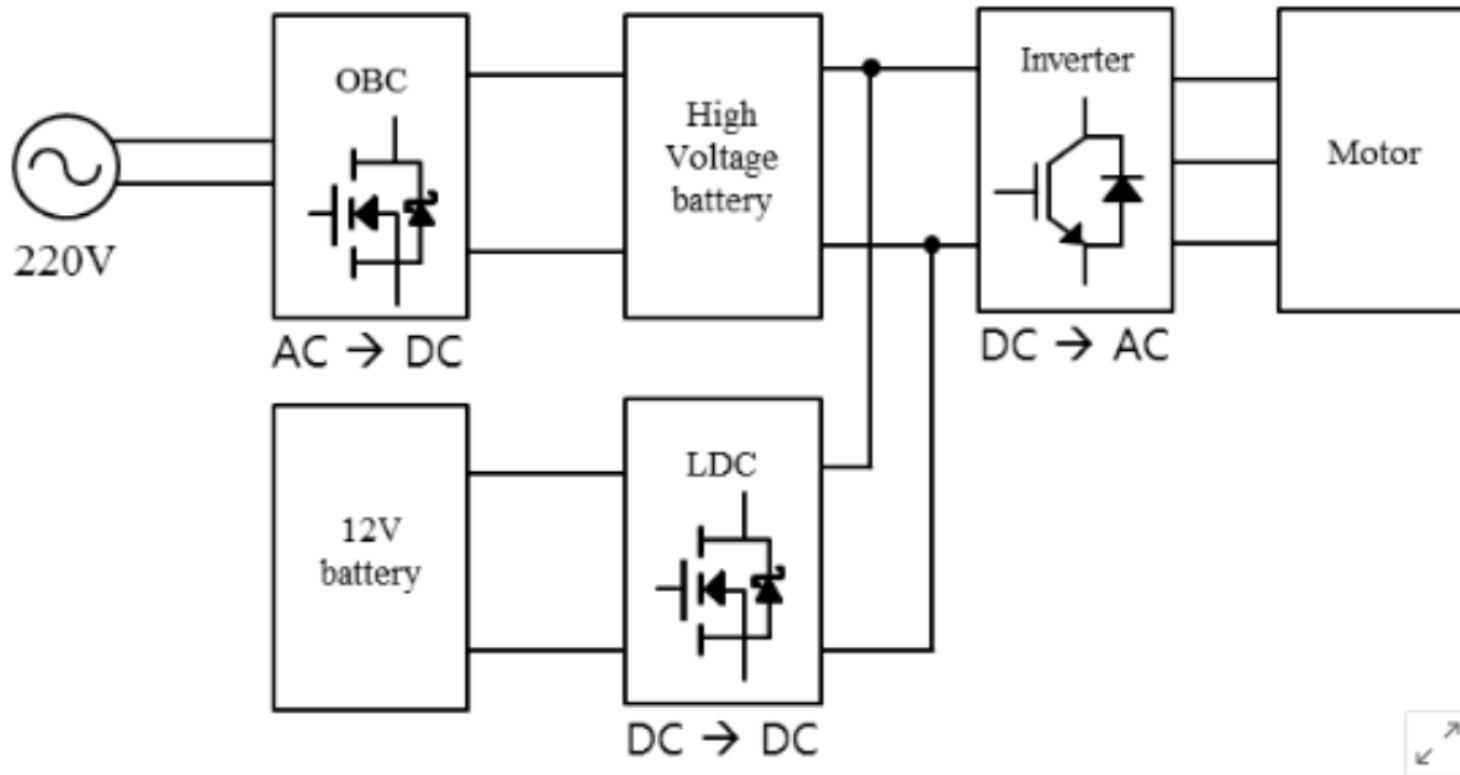

전력변환장치의 구성도

출처: 엠에스리 블로그



Monolithic Power Systems(MPWR)

(백만달러)

	1Q21	2Q21	3Q21	4Q21	1Q22	2Q22	3Q22	4Q22	1Q23
Storage and Computing	51.3	57.8	68.9	78.0	96.6	122.3	112.9	120.8	119.8
Enterprise Data	16.2	29.9	29.7	40.5	42.5	65.2	75.3	68.4	47.2
Automotive	44.9	48.7	54.4	56.4	54.5	61.0	87.1	97.4	105.3
Industrial	39.8	43.3	52.2	49.5	48.5	55.9	58.7	56.1	47.5
Communications	36.1	37.5	44.7	45.9	55.6	59.3	72.3	64.3	67.9
Consumer	66.2	76.1	73.6	66.3	80.0	97.3	89.2	53.0	63.4
Total	254.5	293.3	323.5	336.5	377.7	461.0	495.4	460.0	451.1

(%)

	1Q21	2Q21	3Q21	4Q21	1Q22	2Q22	3Q22	4Q22	1Q23
Storage and Computing	20.2	19.7	21.3	23.2	25.6	26.5	22.8	26.3	26.6
Enterprise Data	6.4	10.2	9.2	12.0	11.3	14.1	15.2	14.9	10.5
Automotive	17.6	16.6	16.8	16.7	14.4	13.2	17.6	21.2	23.4
Industrial	15.6	14.8	16.1	14.7	12.9	12.1	11.9	12.2	10.5
Communications	14.2	12.8	13.8	13.6	14.7	12.9	14.6	14.0	15.1
Consumer	26.0	25.9	22.8	19.7	21.2	21.1	18.0	11.5	14.0

Monolithic Power Systems(MPWR)

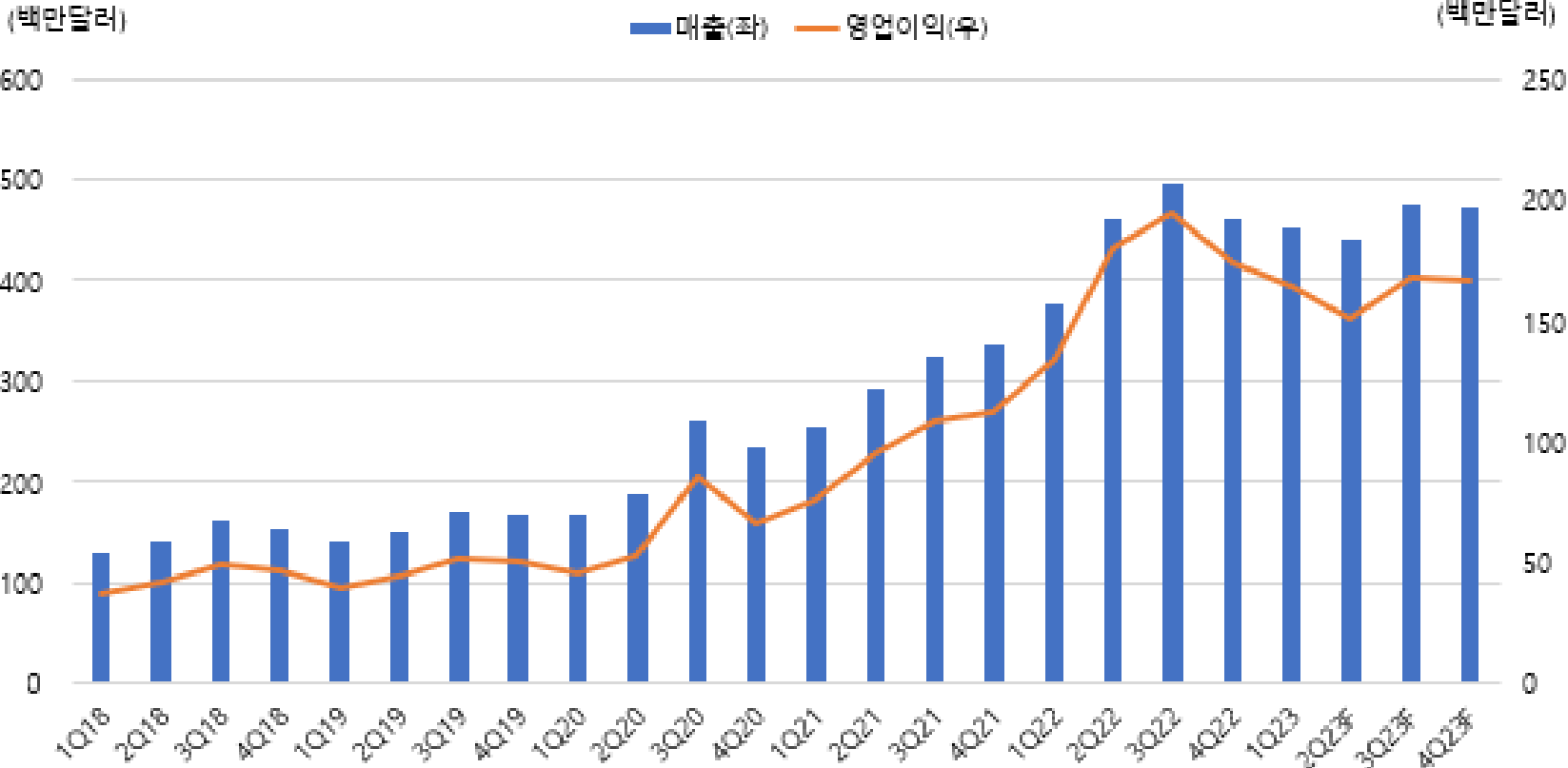

Monolithic Power Systems(MPWR)

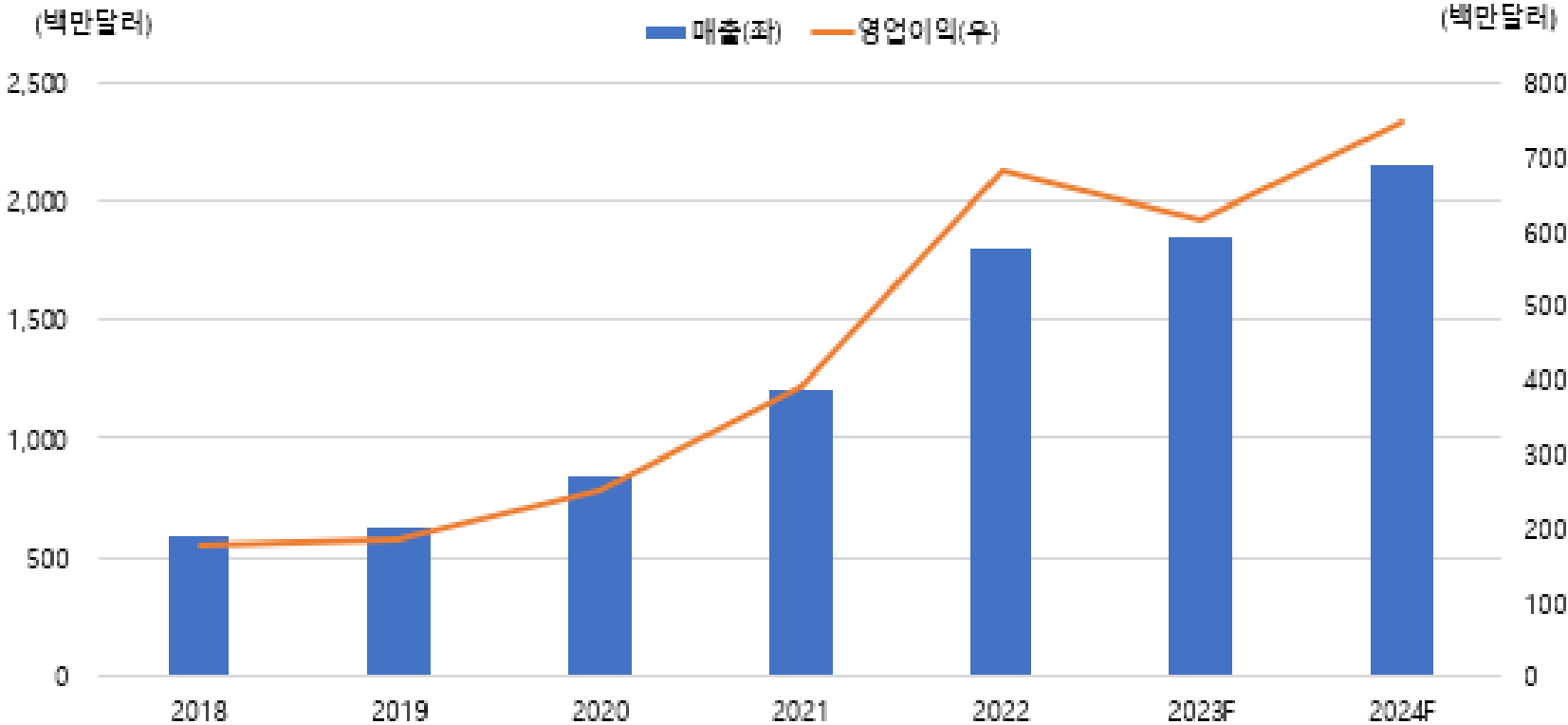

Monolithic Power Systems(MPWR)

